

# KOMATSU

**PC**  
**138us**

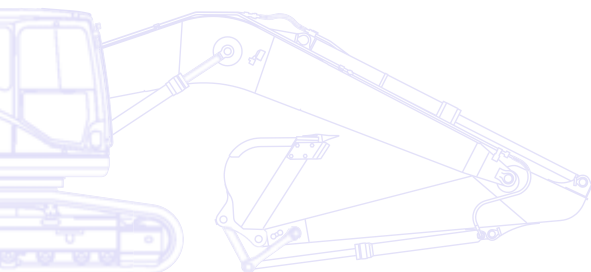

## Hydraulic Excavator **PC138US-10**



**ENGINE POWER**  
72,6 kW / 97,3 HP @ 2.050 rpm

**OPERATING WEIGHT**  
13.700 - 14.870 kg

**BUCKET CAPACITY**  
max. 0,72 m<sup>3</sup>

# Walk-Around

The Komatsu PC138US-10 hydraulic excavator was designed with an ultra-short tail swing to meet the challenges of work in confined areas. With a near-zero tail swing radius, it's the ultimate machine for jobsite safety and is perfect for work on roadways, bridges, in urban areas, or anywhere with limited work space. Built around the EU Stage IIIB/EPA Tier 4 interim engine platform, the PC138US-10 delivers the quality, performance and productivity you can expect from Komatsu equipment.

## First-class operator comfort

- Fully adjustable heated air suspension seat
- Low noise design
- Low vibration levels
- Large, widescreen hi-res display monitor
- Improved operator convenience

## Powerful and environmentally friendly

- Low consumption EU Stage IIIB/EPA Tier 4 interim engine
- Fuel-saving engine and hydraulic technology
- Adjustable Eco-gauge and idle caution
- Reduced wastage

## Total versatility

- Ideal for a wide range of applications
- 6 working modes
- Wide choice of options
- Built-in versatility
- Ultimate operator control



# PC138US-10

**ENGINE POWER**  
72,6 kW / 97,3 HP @ 2.050 rpm

**OPERATING WEIGHT**  
13.700 - 14.870 kg

**BUCKET CAPACITY**  
max. 0,72 m<sup>3</sup>



## Quality you can rely on

- Reliable and efficient
- Rugged design
- Komatsu-quality components
- Extensive dealer support network

## Highest safety standards

- Safe SpaceCab™  
ROPS compliant with ISO 12117-2:2008
- Rear view camera
- Optimal jobsite safety
- Safe access, easy maintenance
- Falling Object Protection System (FOPS) optional

**KOMTRAX**

Komatsu Wireless  
Monitoring System



Complimentary maintenance  
program for customers

# Total Versatility

## Ideal for a wide range of applications

Powerful and precise, the Komatsu PC138US-10 is equipped to efficiently carry out any task your business requires. On big sites or small, for digging, trenching, landscaping or site preparation, the Komatsu original equipment hydraulic system always ensures maximum productivity and control.

## 6 working modes

Power, Lifting, Breaker, Economy, Attachment Power and Attachment Economy modes are all available, ensuring that the PC138US-10 delivers the power you need with minimised fuel usage. The Economy mode can be adjusted for an ideal balance between power and economy to match your work. The oil flow delivered to hydraulic attachments is adjustable directly on the class-leading wide screen monitor panel.

## A wide choice of options

With many options available – such as road-liner track shoes or a dozer blade – you can configure the PC138US-10 to match specific demands for transport, working envelope or duty.

## Built-in versatility

A standard fit additional hydraulic circuit, controlled by a sliding joystick push button and a floor mounted pedal, gives the PC138US-10 excellent versatility. Ten attachment memory settings are provided, with individually definable names. In combination with the standard-fit hydraulic quick coupler power circuit, changing working style is now even simpler. A second auxiliary hydraulic line is available for attachments which require extra hydraulic actuation.

## Short tail swing and exceptional stability

The PC138US-10 has a rounded profile with minimal protrusions at both the front and the rear. Its ultra-short tail swing radius is perfect for work in tight spaces, particularly in urban areas, or for road construction, logging and demolition. Thanks to optimised packaging, the PC138US-10 is exceptionally stable. Coupled with the machine's wide working range, this stability makes it ideal for any work requiring long reach, such as demolition jobs and slope cutting. With ample dumping reach available for loading operations, the operator can always work easily, efficiently and with absolute confidence.





# Powerful and Environmentally Friendly

## New Komatsu engine technology

The powerful and fuel-efficient Komatsu SAA4D95LE-6 engine in the PC138US-10 delivers 72,6 kW / 97,3 HP and is EU Stage IIIB/EPA Tier 4 interim certified. To maximise power, fuel efficiency and emission compliance, it is turbo charged and features direct fuel injection, air-to-air after cooling and cooled EGR.

## Fuel-saving engine and hydraulic technology

The PC138US-10 features variable speed matching of the engine and hydraulic pump, and an automatic low idle. The new engine and pump control technology lower total fuel consumption and guarantee efficiency and precision during single and combined movements.

### **Komatsu Diesel Oxidation Catalyst (KDOC)**

A simple and high efficiency diesel oxidation catalyst that eliminates the need for PM regeneration and simplifies the engine control system. It integrates a high performance exhaust noise silencer and helps to reduce engine noise.

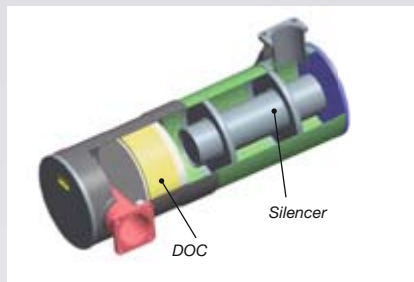

### **Exhaust Gas Recirculation (EGR)**

Cooled EGR is a technology well-proven in current Komatsu engines. The increased capacity of the EGR cooler now ensures very low NOx emissions and a better engine performance.

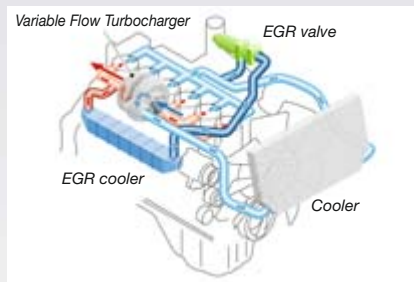

### **Variable Flow Turbocharger (VFT)**

Varies the intake air-flow. The wheel speed of the exhaust turbine is controlled by a valve for optimum air flow to the engine combustion chamber, under any load or speed conditions. The exhaust gas is cleaner, with no reduction in power or performance.

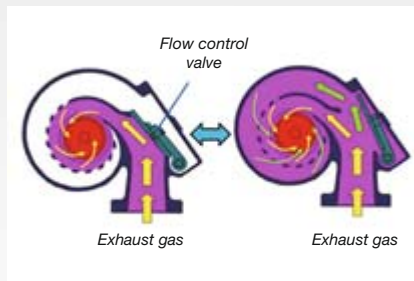

### **Komatsu Closed Crankcase Ventilation (KCCV)**

Crankcase emissions (blow-by gas) are passed through a CCV filter. The oil mist trapped in the filter is returned back to the crankcase while the filtered gas is returned to the air intake.

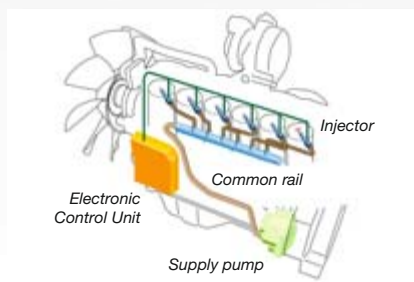

### **High-Pressure Common Rail (HPCR)**

To achieve complete fuel burn and lower exhaust emissions, the heavy duty High-Pressure Common Rail fuel injection system is computer controlled to deliver a precise quantity of pressurised fuel into the redesigned engine combustion chamber by multiple injections.



## Reduced wastage

Standard equipment on all PC138US-10 includes an electric fuel pump, simple to operate and with an automatic shut-off. To further increase the system's safety, a barrier and special foams help to avoid any spilt fuel flowing towards hot areas of the machine.



### More fuel-saving technology

The selectable engine mode and adjustable idle shutdown are tools to considerably lower fuel usage. The PC138US-10's Eco-gauge displays active recommendations on the cab's monitor to help you maximise those fuel savings.



Active ECO recommendations



ECO guidance menu

# First-Class Operator Comfort

## Newly designed, spacious cab

The wide and spacious cab includes a newly designed heated air suspension seat with a high backrest. The seat height and longitudinal inclination are easily adjusted with a pull-up lever. You can also set the operational posture of the armrest and the position of the console or recline the seat all the way and place it into a fully flat state with the headrest attached.

## Improved operator convenience

With increased in-cab storage space, an auxiliary input (MP3 jack) and 12 V and 24 V power supply, the cab offers maximum convenience. The automatic air conditioner allows the operator to easily and precisely set the cab's atmosphere.

## Low noise design

Komatsu Dash 10 crawler excavators have very low external noise levels and are especially well-suited for work in confined spaces or urban areas. Reduced fan speed, a large capacity radiator, and the optimal usage of sound insulation and of sound absorbing materials help to make noise levels inside Dash 10 excavators comparable to those inside an executive car.

## Cab damper mounting

The built-in stability of the Komatsu PC138US-10, combined with a highly rigid deck and a sprung multi-layer viscous mount system, drastically reduces vibration levels for the operator.



MP3 jack



Joysticks with proportional control button for attachments



DeLuxe seat



## Large, widescreen hi-res display monitor

To enable safe, accurate and smooth work, the user friendly monitor is the highly intuitive user interface for the machine's Equipment Management and Monitoring System (EMMS). Easily customized and with a choice of 25 languages, it features simple switches and multifunction keys that provide the operator with fingertip access to a wide range of functions and operating information.

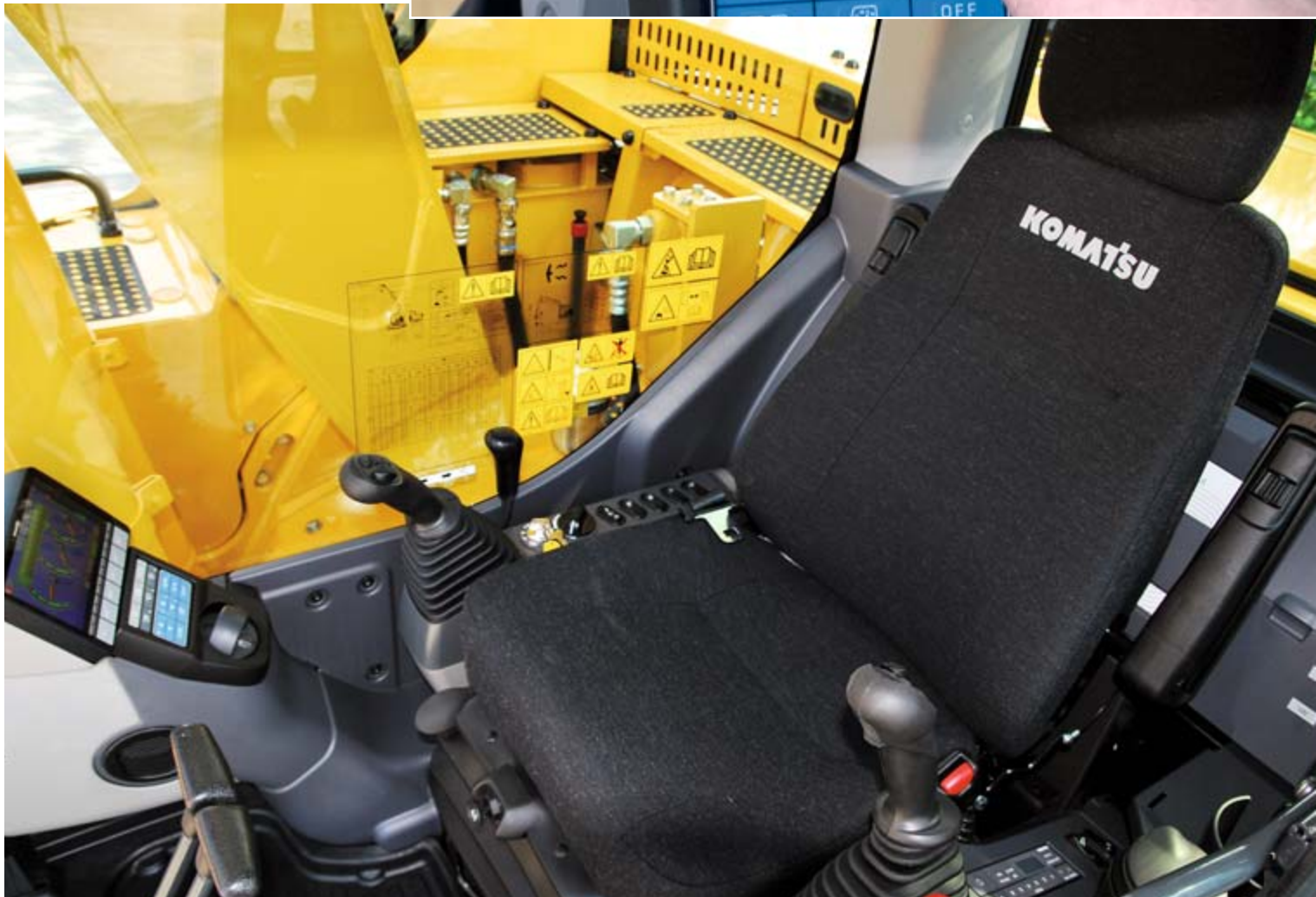

# Highest Safety Standards

## Safe operation in confined areas

The machine's rounded profile allows it to operate in narrow spaces or where there are a number of obstructions. The compact tail design minimises the risks of rear impact and lets the operator concentrate fully on his work.

## Safe SpaceCab™

The new cab is ROPS compliant with ISO 12117-2:2008. It has a tubular steel frame and provides very high shock absorbency, impact resistance and durability. The seat belt is designed to keep the operator in the safety zone of the cab in the event of a roll-over. Optionally it can be fitted with an ISO 10262 Level 2 Falling Object Protective System (FOPS) with openable front guard.



Safe SpaceCab™

## Optimal job site safety

Safety features on the Komatsu PC138US-10 comply with the latest industry standards and work together as a system to minimise risks to personnel in and around the machine. An audible travel alarm further promotes job site safety. Highly durable anti-slip plates – with additional high friction covering – maintain long term traction performance.

## Rear view camera

A standard fitment camera gives an exceptionally clear view of the rear work zone on the wide-screen monitor panel. Large mirrors on both sides ensure that machine visibility meets the latest ISO standards.



Large handrails

## Short tail swing radius

1,48 m – Because the tail of the PC138US-10 is more compact than conventional models, the PC138US-10 reduces the operator's need to check behind him for movement.

## Short implement swing radius

1,98 m – Boom raising angle of the PC138US-10 is larger than on a conventional profile excavator, while front implement protrusion is lessened.



Rear view camera

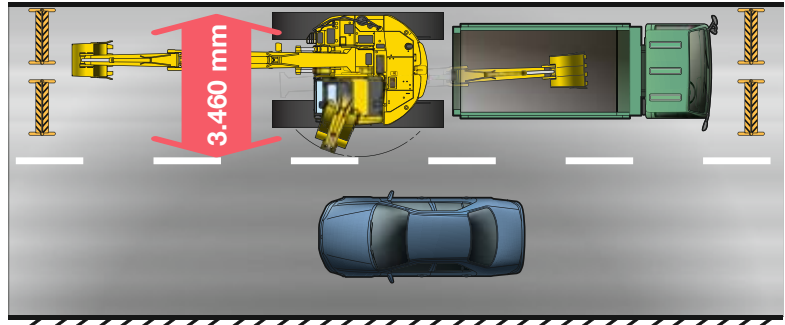

*When performing road work, protrusion of the machine into the unoccupied lane is kept to a minimum. This allows a dump truck to be positioned closer to the track of the machine.*



# Quality You Can Rely On

## Reliable and efficient

Productivity is the key to success – all major components of the PC138US-10 are designed and directly manufactured by Komatsu. Essential machine functions are perfectly matched for a highly reliable and productive machine.

## Rugged design

Maximum toughness and durability – along with top class customer service – are the cornerstones of Komatsu's philosophy. Single piece plates and castings are used in key areas of the machine's structure for good load distribution. Highly durable rubbing strips on the underside of the arm protect the structure against material falling from the bucket.

## Komatsu-quality components

With the latest computer design techniques and a thorough test programme, Komatsu's global know-how produces machines that are designed, manufactured and tested to meet your highest standards.

## Extensive dealer support network

The extensive Komatsu distribution and dealer network is standing by to help keep your fleet in optimum condition. Customised servicing packages are available, with express availability of spare parts, to make sure that your Komatsu will continue to perform at its peak.





# Komatsu Wireless Monitoring System

## The easy way to higher productivity

KOMTRAX™ is the latest in wireless monitoring technology. It delivers insightful and cost saving information about your fleet and equipment and offers you a wealth of information to facilitate peak machine performance. By creating a tightly integrated web of support it allows pro active and preventive maintenance and helps you to efficiently run a business.

## Knowledge

You get quick answers to basic and critical questions about your machines - what they're doing, when they did it, where they're located, how they can be used more efficiently, and when they need to be serviced. Performance data is relayed by satellite from your machine to your computer and to your local Komatsu distributor - who's readily available for expert analysis and feedback.

## Convenience

KOMTRAX™ helps to conveniently manage your fleet on the web, wherever you are. Data is analysed and packaged specifically for easy and intuitive viewing in maps, lists, graphs and charts. You can anticipate the type of service and parts your machines could require, or troubleshoot problems before Komatsu technicians arrive on site.



## Power

The detailed information that KOMTRAX™ puts at your fingertips 24 hours a day, 7 days a week gives you the power to make better daily and long-term strategic decisions. You can anticipate problems, customize maintenance schedules, minimize downtime and keep your machines where they belong – working on the job site.



Through the web application, a variety of search parameters are available to quickly find information about specific machines based on key factors such as utilization rates, age, various notification messages, and more.

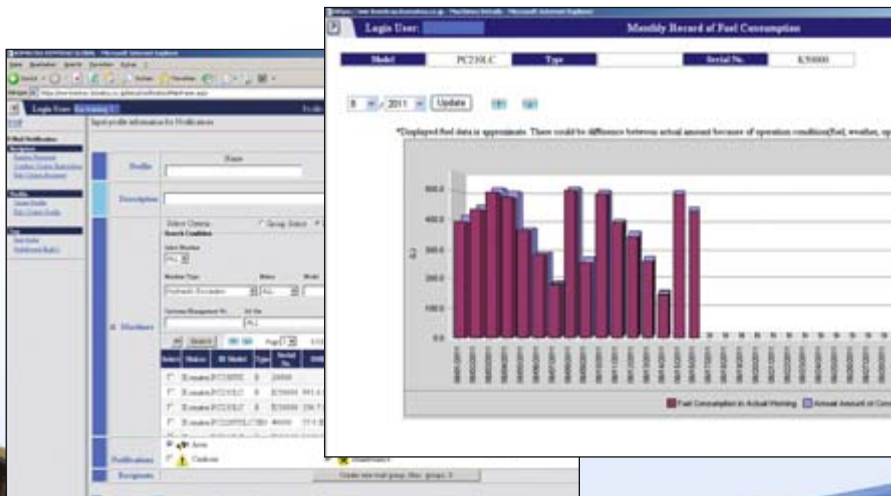

A simple chart shows the machine's fuel consumption and helps you to calculate total costs for a job site and conveniently schedule fuel deliveries.



# Easy Maintenance

## Optimum maintenance layout

Effortless access to engine-related maintenance items such as oil filter, oil dipstick, coolant reserve tank, fuel filter, and air cleaner.

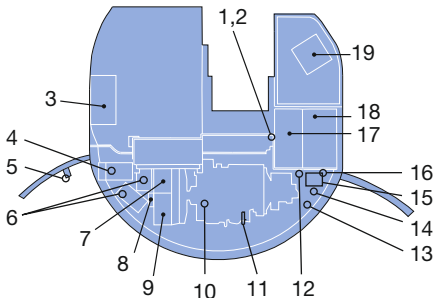

1. Swing machinery dipstick
2. Swing machinery oil filler
3. Tool box
4. Air cleaner
5. Windshield washer tank
6. Batteries
7. Oil cooler
8. Aftercooler
9. Radiator
10. Engine oil filler
11. Engine oil dipstick
12. Engine oil filter
13. PTO oil filler
14. Fuel drain valve
15. Coolant reserve tank
16. Fuel filter (with water separator)
17. Hydraulic tank
18. Fuel tank
19. Control valve

## Water separator

This is standard equipment which removes any water that has become mixed with the fuel, preventing fuel system damage.



Komatsu CARE is a complimentary maintenance program for Komatsu customers that comes as standard with every new Komatsu EU Stage IIIB construction machine. For the first 3 years or 2,000 hours it covers factory-scheduled maintenance, performed by Komatsu-trained technicians with Komatsu Genuine parts.

## Long-life oil filters

The hydraulic oil filter uses high-performance filtering material for long element replacement intervals, which significantly reduces maintenance costs.



## Side-by-side cooling

Since the radiator, aftercooler and oil cooler are arranged in parallel, it is easy to clean, remove and install them.

## Long greasing interval

Special hard material is used for the bushings of the work equipment to lengthen greasing interval. All bushing lubrication intervals of work equipment except arm top bushing are 500 hours, reducing maintenance costs.





## ENGINE

Model .....	Komatsu SAA4D95LE-6
Type .....	Common rail direct injection, water-cooled, emissionised, turbocharged, after-cooled diesel
Engine power	
at rated engine speed .....	2.050 rpm
ISO 14396 .....	72,6 kW / 97,3 HP
ISO 9249 (net engine power) .....	69,7 kW / 93,5 HP
No. of cylinders .....	4
Bore x stroke .....	95 x 115 mm
Displacement .....	3,26 ltr
Starter motor .....	4,5 kW
Alternator .....	24 V/60 A
Battery .....	2 x 12 V/72 Ah
Air filter type .....	Double element type with monitor panel dust indicator and auto dust evacuator

## HYDRAULIC SYSTEM

Type .....	HydrauMind. Closed-centre system with load sensing and pressure compensation valves
Main pump .....	Variable-capacity piston pump
Pumps for .....	Boom, arm, bucket, swing, and travel circuits
Maximum pump flow .....	242 ltr/min
Hydraulic motors:	
Travel .....	2 x axial piston motor with parking brake
Swing .....	1 x axial piston motor with swing holding brake
Relief valve settings:	
Implement .....	355 bar
Travel .....	355 bar
Swing .....	276 bar
Pilot .....	33 bar

## DRIVES AND BRAKES

Steering control .....	2 levers with pedals giving full independent control of each track
Drive method .....	Hydrostatic
Max. drawbar pull .....	12.500 kgf
Max. travel speeds	
Lo / Hi .....	2,9 / 5,1 km/h

## SWING SYSTEM

Type .....	Axial piston motor driving through planetary double reduction gearbox
Swing lock .....	Electrically actuated wet multi-disc brake integrated into swing motor
Swing speed .....	0 - 11 rpm
Swing torque .....	33 kNm

## UNDERCARRIAGE

Construction .....	X-frame centre section with box section track frames
Track assembly	
Type .....	Fully sealed
Shoes (each side) .....	43
Tension .....	Combined spring and hydraulic unit
Rollers	
Track rollers (each side) .....	7
Carrier rollers (each side) .....	1

## SERVICE REFILL CAPACITIES

Fuel tank .....	200 ltr
Radiator .....	17,7 ltr
Engine .....	11,5 ltr
Final drive (each side) .....	2,1 ltr
Swing drive .....	2,5 ltr
Hydraulic tank .....	69 ltr

## ENVIRONMENT

Engine emissions .....	Fully complies with EU Stage IIIB and EPA Tier 4 interim exhaust emission regulations
Noise levels	
LwA external .....	100 dB(A) (2000/14/EC Stage II)
LpA operator ear .....	72 dB(A) (ISO 6396 dynamic test)
Vibration levels (EN 12096:1997)*	
Hand/arm .....	≤ 2,5 m/s <sup>2</sup> (uncertainty K = 0,63 m/s <sup>2</sup> )
Body .....	≤ 0,5 m/s <sup>2</sup> (uncertainty K = 0,25 m/s <sup>2</sup> )

\* for the purpose of risk assessment under directive 2002/44/EC, please refer to ISO/TR 25398:2006.

# Specifications

## OPERATING WEIGHT (APPR.)

	MONO BOOM		TWO-PIECE BOOM	
	Operating weight	Ground pressure	Operating weight	Ground pressure
Triple grouser shoes				
500 mm	13.700 kg	0,43 kg/cm <sup>2</sup>	14.250 kg	0,47 kg/cm <sup>2</sup>
600 mm	13.870 kg	0,36 kg/cm <sup>2</sup>	14.690 kg	0,41 kg/cm <sup>2</sup>
700 mm	14.050 kg	0,32 kg/cm <sup>2</sup>	14.870 kg	0,36 kg/cm <sup>2</sup>
500 mm road liner	13.820 kg	0,43 kg/cm <sup>2</sup>	14.640 kg	0,47 kg/cm <sup>2</sup>

Operating weight, including 2,5 m arm, 470 kg bucket, operator, lubricant, coolant, full fuel tank and the standard equipment.  
Additional weight with blade: + 850 kg

## MAX. BUCKET CAPACITY AND WEIGHT

Arm length	MONO BOOM					
	2,1 m		2,5 m		3,0 m	
Material weight up to 1,2 t/m <sup>3</sup>	0,80 m <sup>3</sup>	610 kg	0,72 m <sup>3</sup>	539 kg	0,72 m <sup>3</sup>	539 kg
Material weight up to 1,5 t/m <sup>3</sup>	0,72 m <sup>3</sup>	539 kg	0,64 m <sup>3</sup>	513 kg	0,64 m <sup>3</sup>	513 kg
Material weight up to 1,8 t/m <sup>3</sup>	0,64 m <sup>3</sup>	513 kg	0,56 m <sup>3</sup>	475 kg	0,49 m <sup>3</sup>	445 kg

## MAX. BUCKET CAPACITY AND WEIGHT

Arm length	TWO-PIECE BOOM			
	2,1 m		2,5 m	
Material weight up to 1,2 t/m <sup>3</sup>	0,80 m <sup>3</sup>	610 kg	0,72 m <sup>3</sup>	539 kg
Material weight up to 1,5 t/m <sup>3</sup>	0,72 m <sup>3</sup>	539 kg	0,64 m <sup>3</sup>	513 kg
Material weight up to 1,8 t/m <sup>3</sup>	0,64 m <sup>3</sup>	513 kg	0,56 m <sup>3</sup>	475 kg

Max. capacity and weight have been calculated according to ISO 10567:2007.

Please consult with your distributor for the correct selection of buckets and attachments to suit the application.

## BUCKET AND ARM COMBINATION

Arm length	Capacity SAE	No. of teeth	Width	Weight	MONO BOOM			TWO-PIECE BOOM	
					2,1 m	2,5 m	3,0 m	2,1 m	2,5 m
0,26 m <sup>3</sup>		3	500 mm	339 kg	○	○	○	○	○
0,33 m <sup>3</sup>		3	600 mm	366 kg	○	○	○	○	○
0,41 m <sup>3</sup>		4	700 mm	409 kg	○	○	○	○	○
0,49 m <sup>3</sup>		4	800 mm	445 kg	○	○	○	○	○
0,64 m <sup>3</sup>		5	1.000 mm	513 kg	○	○	□	○	○
0,72 m <sup>3</sup>		5	1.100 mm	539 kg	○	□	△	○	□
0,79 m <sup>3</sup>		5	1.200 mm	566 kg	□	△	–	□	△
0,60 m <sup>3</sup>	Ditch cleaning bucket		2.000 mm	395 kg	○	○	○	○	○
0,66 m <sup>3</sup>	Ditch cleaning bucket		2.200 mm	426 kg	○	○	○	○	○

Material weight up to 1,2 t/m<sup>3</sup> △  
Material weight up to 1,5 t/m<sup>3</sup> □  
Material weight up to 1,8 t/m<sup>3</sup> ○  
Not usable –

## MACHINE DIMENSIONS

E	Overall height of cab	2.815 mm
F	Clearance under counterweight	900 mm
G	Ground clearance	395 mm
H	Tail swing radius	1.480 mm
I	Tumbler centre distance	2.880 mm
J	Track length	3.610 mm
K	Track gauge	1.990 mm
L	Overall track width with 500 mm shoes	2.490 mm
	Overall track width with 600 mm shoes	2.590 mm
	Overall track width with 700 mm shoes	2.690 mm
M	Shoe width	500, 600, 700 mm
N	Grouser height	20 mm
O	Machine tail height	2.140 mm
P	Overall width of upper structure	2.490 mm
Q	Distance, swing center to rear end	1.480 mm
R	Distance, swing center to blade	2.500 mm
S	Blade, max. lifting height	470 mm
T	Height of blade	590 mm
U	Blade, max. digging depth	525 mm
	Blade width (with 500 mm shoes)	2.490 mm
	Blade width (with 600 mm shoes)	2.590 mm

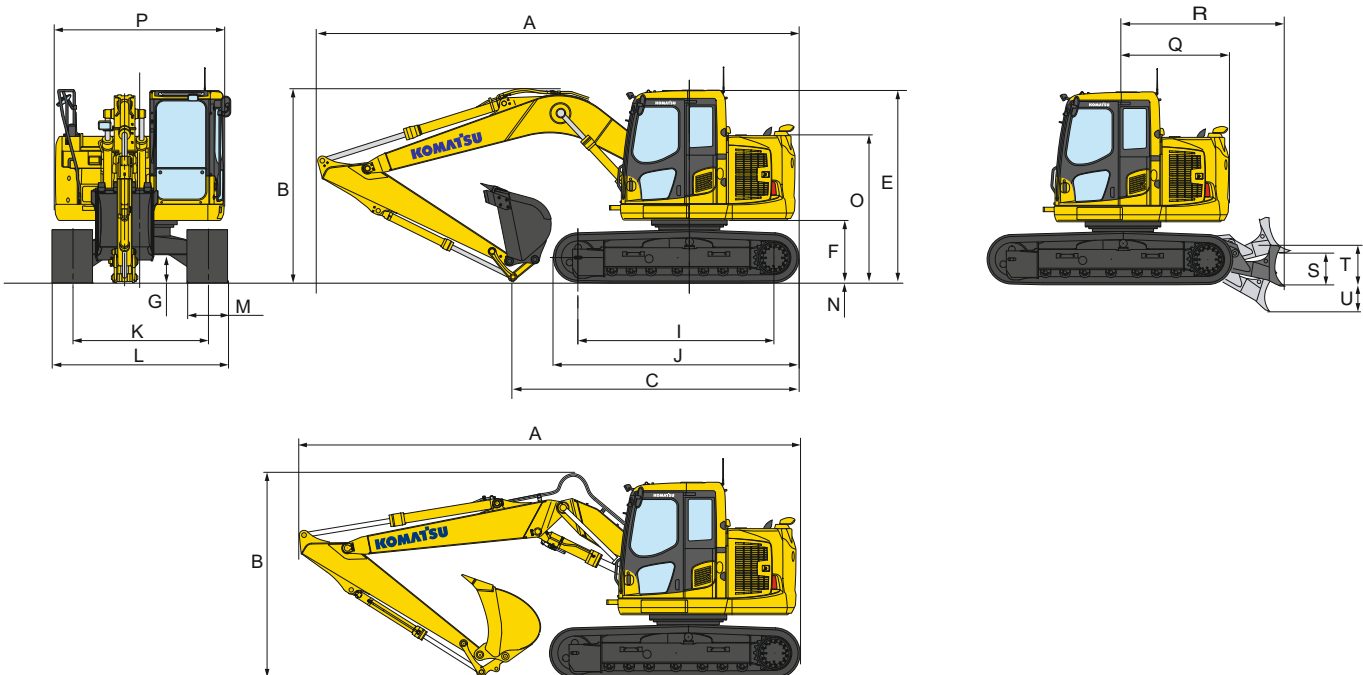

## TRANSPORT DIMENSIONS

### MONO BOOM

### TWO-PIECE BOOM

	2,1 m	2,5 m	3,0 m	2,1 m	2,5 m	
A	Transport length	7.290 mm	7.275 mm	7.160 mm	8.110 mm	8.100 mm
B	Overall height (to top of boom)	2.820 mm	2.950 mm	3.210 mm	-	-
B	Overall height (to top of hose)	-	-	-	2.920 mm	3.050 mm
C	Length on ground (transport)	4.600 mm	4.400 mm	4.290 mm	4.970 mm	4.730 mm

# Working Range

## MONO BOOM

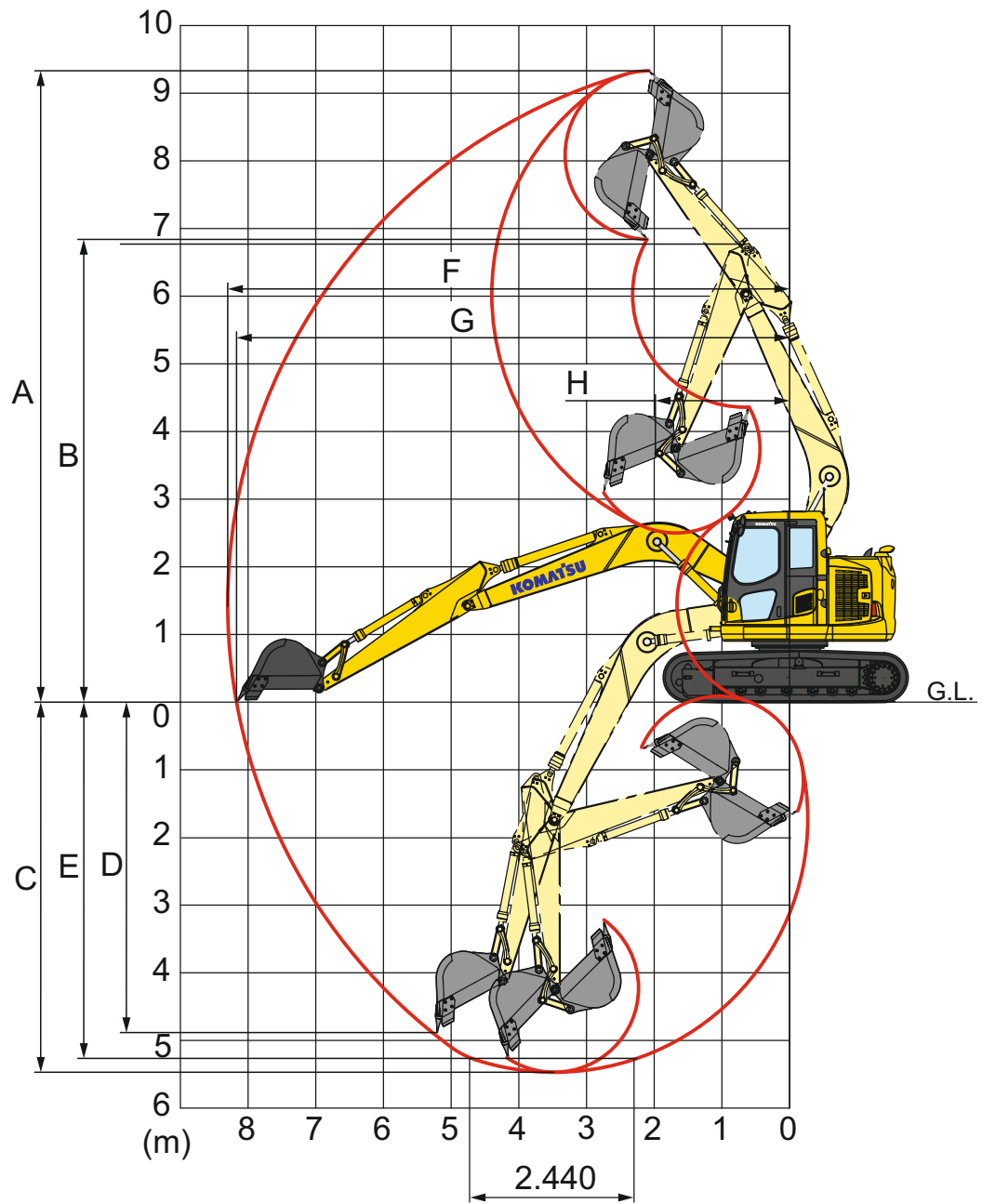

ARM LENGTH	2,1 m	2,5 m	3,0 m
A Max. digging height	9.020 mm	9.340 mm	9.700 mm
B Max. dumping height	6.525 mm	6.840 mm	7.350 mm
C Max. digging depth	5.070 mm	5.480 mm	5.900 mm
D Max. vertical wall digging depth	4.490 mm	4.900 mm	5.340 mm
E Max. digging depth of cut for 2,44 m level	4.830 mm	5.265 mm	5.715 mm
F Max. digging reach	7.930 mm	8.300 mm	8.720 mm
G Max. digging reach at ground level	7.805 mm	8.180 mm	8.600 mm
H Min. swing radius	1.845 mm	1.980 mm	2.265 mm
Bucket digging force (ISO)	9.500 kgf	9.500 kgf	9.500 kgf
Arm crowd force (ISO)	7.300 kgf	6.300 kgf	5.700 kgf

## TWO-PIECE BOOM

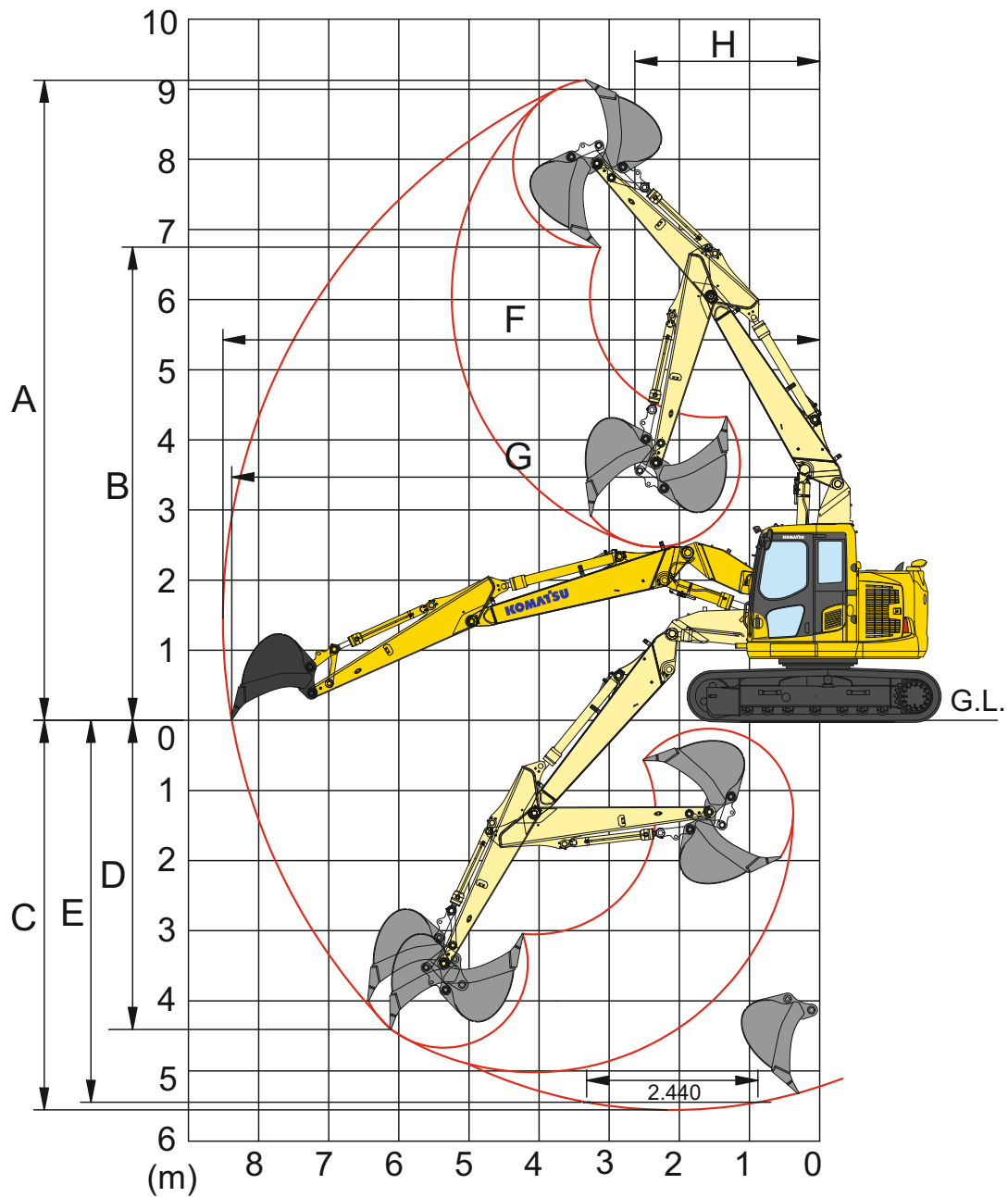

ARM LENGTH	2,1 m	2,5 m
A Max. digging height	8.830 mm	9.130 mm
B Max. dumping height	6.455 mm	6.750 mm
C Max. digging depth	5.280 mm	5.680 mm
D Max. vertical wall digging depth	4.000 mm	4.400 mm
E Max. digging depth of cut for 2,44 m level	5.140 mm	5.570 mm
F Max. digging reach	8.140 mm	8.510 mm
G Max. digging reach at ground level	8.000 mm	8.380 mm
H Min. swing radius	2.380 mm	2.500 mm

# Lifting Capacity

## MONO BOOM

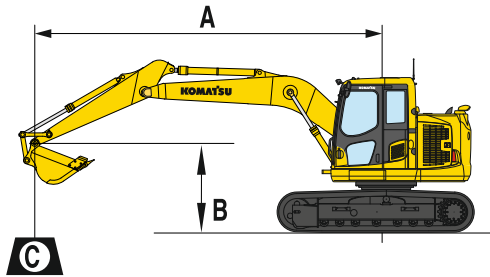

A – Reach from swing center

B – Bucket hook height

C – Lifting capacities, including bucket (450 kg), bucket linkage and bucket cylinder















When removing bucket, linkage or cylinder, lifting capacities can be increased by their respective weights



With 500 mm shoes

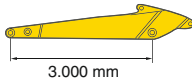

 – Rating over front

 – Rating over side

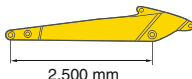
 – Rating at maximum reach

Arm length	A				7,0 m		6,0 m		4,5 m		3,0 m		1,5 m	
	B													
 3.000 mm  450 kg 0,5 m <sup>3</sup>	6,0 m	kg	*1.340	*1.340			*1.870	*1.870	*2.670	*2.670				
	4,5 m	kg	*1.250	*1.250	*1.600	1.430	*2.680	1.950	*2.840	*2.840				
	3,0 m	kg	*1.250	1.170	2.250	1.400	2.950	1.870	*3.760	3.090	*3.740	*3.740		
	1,5 m	kg	*1.330	1.090	2.180	1.340	2.830	1.760	4.580	2.840	*7.560	5.440		
	0,0 m	kg	*1.500	1.100	2.120	1.280	2.720	1.660	4.330	2.620	*6.480	4.930		
	-1,5 m	kg	*1.810	1.200	2.080	1.250	2.650	1.600	4.200	2.500	*6.220	4.760	*3.840	*3.840
	-3,0 m	kg	2.460	1.490			2.660	1.600	4.180	2.490	*6.480	4.780	*5.760	*5.760
	-4,5 m	kg	*2.920	2.290							*3.500	2.590	*5.500	4.950

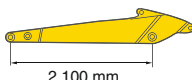
 2.500 mm  450 kg 0,5 m <sup>3</sup>	6,0 m	kg	*1.650	*1.650					*3.100	*3.100				
	4,5 m	kg	*1.540	*1.540			*2.850	1.920	*3.570	3.210				
	3,0 m	kg	*1.550	1.340	*1.970	1.390	2.930	1.860	*4.360	3.040	*5.880	*5.880		
	1,5 m	kg	*1.660	1.250	2.180	1.340	2.830	1.770	4.540	2.820	*7.430	5.310		
	0,0 m	kg	*1.910	1.260	2.140	1.300	2.740	1.680	4.340	2.640	*6.090	4.940		
	-1,5 m	kg	2.310	1.410			2.700	1.640	4.250	2.560	*6.070	4.860	*4.370	*4.370
	-3,0 m	kg	2.940	1.800					4.270	2.570	*6.540	4.920	*5.750	*5.750
	-4,5 m	kg												

 2.100 mm  450 kg 0,5 m <sup>3</sup>	6,0 m	kg	*2.060	*2.060					*3.420	3.190				
	4,5 m	kg	*1.900	1.770			*2.600	1.880	*3.960	3.160	*4.220	*4.220		
	3,0 m	kg	*1.920	1.480			2.910	1.840	*4.680	2.990	*6.630	5.830		
	1,5 m	kg	*2.070	1.370			2.820	1.760	4.500	2.780	*6.570	5.170		
	0,0 m	kg	2.280	1.400			2.740	1.690	4.330	2.630	*5.990	4.900		
	-1,5 m	kg	2.570	1.580			2.720	1.670	4.260	2.570	*6.090	4.880	*4.830	*4.830
	-3,0 m	kg	3.420	2.100					4.310	2.610	*6.680	4.990	*5.910	*5.910
	-4,5 m	kg												

\* Load is limited by hydraulic capacity rather than tipping.

Ratings are based on SAE Standard No. J1097.

Rated loads do not exceed 87% of hydraulic lift capacity or 75% of tipping load.



## TWO-PIECE BOOM

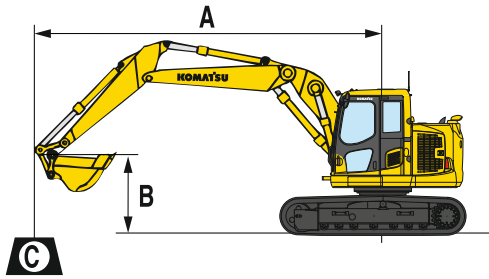

















- A** – Reach from swing center
- B** – Bucket hook height
- C** – Lifting capacities, including bucket (450 kg), bucket linkage and bucket cylinder

When removing bucket, linkage or cylinder, lifting capacities can be increased by their respective weights

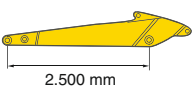
With 500 mm shoes

-  – Rating over front
-  – Rating over side
-  – Rating at maximum reach

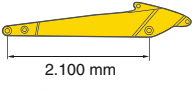
Arm length	A				7,5 m		6,0 m		4,5 m		3,0 m		1,5 m	
	B													
 2.500 mm  450 kg 0,5 m <sup>3</sup>	7,5 m	kg	*2.500	*2.500										
	6,0 m	kg	*2.050	*2.050					*3.100	*3.100				
	4,5 m	kg	*1.900	1.550			2.750	2.050	*3.350	*3.350				
	3,0 m	kg	1.800	1.300			2.700	1.950	*4.100	3.250	*5.850	*5.850		
	1,5 m	kg	1.700	1.200	1.700	1.200	2.550	1.850	4.200	3.000				
	0,0 m	kg	1.700	1.200	1.700	1.200	2.450	1.750	4.000	2.800				
	-1,5 m	kg	1.900	1.350			2.400	1.700	3.900	2.700	*7.500	4.600		
	-3,0 m	kg	2.400	1.700			2.450	1.700	3.900	2.700	*7.450	5.300		
	-4,5 m	kg												

 2.100 mm  450 kg 0,5 m <sup>3</sup>	7,5 m	kg	*3.200	*3.200										
	6,0 m	kg	*2.500	2.350					*3.500	*3.500				
	4,5 m	kg	*2.350	1.700			2.700	2.000	*3.700	3.450				
	3,0 m	kg	2.000	1.450			2.650	1.950	4.350	3.200	*6.550	6.300		
	1,5 m	kg	1.850	1.350			2.550	1.850	4.150	2.950				
	0,0 m	kg	1.900	1.350			2.450	1.750	3.950	2.750				
	-1,5 m	kg	2.150	1.500			2.450	1.750	3.900	2.700	*7.750	4.650		
	-3,0 m	kg	2.800	2.000					3.950	2.750	*6.850	5.400		
	-4,5 m	kg												

\* Load is limited by hydraulic capacity rather than tipping.  
 Ratings are based on SAE Standard No. J1097.  
 Rated loads do not exceed 87% of hydraulic lift capacity or 75% of tipping load.

# Hydraulic Excavator

## PC138US-10

### Standard and Optional Equipment

#### ENGINE

Komatsu SAA4D95LE-6 turbocharged common rail direct injection diesel engine	●
EU Stage IIIB/EPA Tier 4 interim compliant	●
Automatic engine warm-up system	●
Engine overheat prevention system	●
Fuel control dial	●
Auto-deceleration function	●
Engine key stop	●
Engine ignition can be password secured on request	●
Alternator 24 V/35 A	●
Starter motor 24 V/4,5 kW	●
Batteries 2 × 12 V/72 Ah	●

#### HYDRAULIC SYSTEM

Electronic closed-centre load sensing (E-CLSS) hydraulic system (HydrauMind)	●
Pump and engine mutual control (PEMC) system	●
One additional hydraulic circuit	●
6-working mode selection system; power mode, economy mode, breaker mode, attachment power and attachment economy mode, and lifting mode	●
Adjustable PPC wrist control levers for arm, boom, bucket and swing, with sliding proportional control for attachments and 3 auxiliary buttons	●
Prepared for hydraulic quick-coupler	●
Additional hydraulic functions	○

#### DRIVES AND BRAKES

Hydrostatic, 2-speed travel system with automatic shift and planetary gear type final drives, and hydraulic travel and parking brakes	●
PPC control levers and pedals for steering and travel	●

#### UNDERCARRIAGE

Track frame under-guards	●
500 mm triple grouser shoes	●
600, 700 mm triple grouser shoes	○
500 mm road-liner (rubber) shoes	○

#### CABIN

Reinforced safety SpaceCab™; highly pressurised and tightly sealed hyper viscous mounted cab with tinted safety glass windows, large roof window with sun shade, pull-up type front window with locking device, removable lower window, front window wiper with intermittent feature, sun roller blind, cigarette lighter, ashtray, luggage shelf, floor mat	●
Heated, high back air suspension seat with lumbar support, console mounted height adjustable arm rests, and retractable seat belt	●
Automatic climate control system	●
12/24 Volt power supplies	●
Beverage holder and magazine rack	●
Hot and cool box	●
Radio	●
Auxiliary input (MP3 jack)	●
Lower wiper	○
Rain visor (not with OPG)	○

#### SERVICE AND MAINTENANCE

Automatic fuel line de-aeration	●
Double element type air cleaner with dust indicator and auto dust evacuator	●
KOMTRAX™ – Komatsu wireless monitoring system	●
Multi-function video compatible colour monitor with Equipment Management and Monitoring System (EMMS) and efficiency guidance	●
Toolkit	●
Komatsu CARE	●
Service points	○

#### WORK EQUIPMENT

Mono boom	○
Two-piece boom	○
2,1 m; 2,5 m; 3,0 m arms	○
Dozer blade (with 500 or 600 mm shoes)	○
Komatsu buckets	○
Komatsu breakers	○

#### SAFETY EQUIPMENT

Rear view camera system	●
Electric horn	●
Overload warning device	●
Audible travel alarm	●
Boom safety valves	●
Large handrails, rear-view mirrors	●
Battery main switch	●
ROPS compliant to ISO 12117-2:2008	●
Emergency engine stop switch	●
Arm safety valve	●
OPG Level II front guard (FOPS), hinged type	○
OPG Level II top guard (FOPS)	○

#### LIGHTING SYSTEM

Working lights: 1 revolving frame and 1 boom (r.h.)	●
Additional working lights: 5 cab roof, 1 boom (l.h.), 1 counterweight (rear), additional revolving frame (l.h.), beacon and harness for 2 lamps (not included) in boom foot area	○

#### OTHER EQUIPMENT

Remote greasing for swing circle and pins	●
Electric refuelling pump with automatic shut off function	●
Standard colour scheme and decals	●
Parts book and operator manual	●
Additional counterweight 500 kg	○

Further equipment on request

- standard equipment
- optional equipment

Your Komatsu partner:

# KOMATSU

**Komatsu Europe International NV**  
 Mechelsesteenweg 586  
 B-1800 VILVOORDE (BELGIUM)  
 Tel. +32-2-255 24 11  
 Fax +32-2-252 19 81  
[www.komatsu.eu](http://www.komatsu.eu)

UENSS16602 12/2014

Materials and specifications are subject to change without notice.  
**KOMATSU** is a trademark of Komatsu Ltd. Japan.